

SPI

Simple application, only need a single data cable can complete the transmission of data;

Breakpoint Transmission

With dual data cable, the main data cable can be automatically switched to the standby data cable when the fault, enhance the reliability of data transmission;

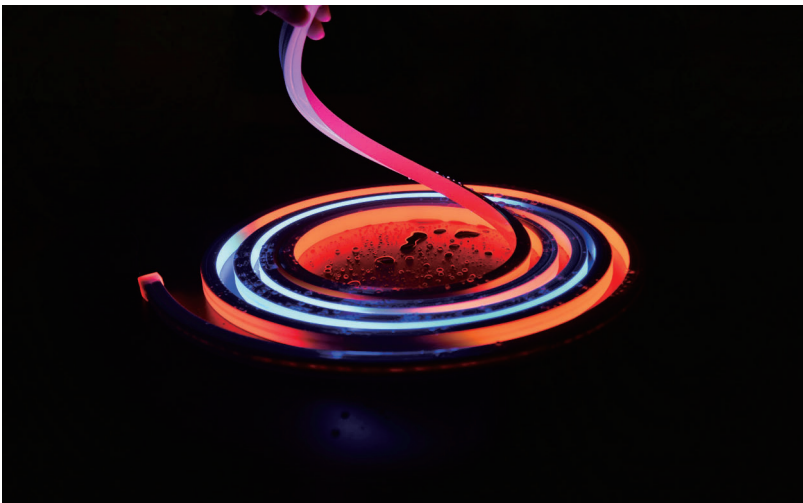
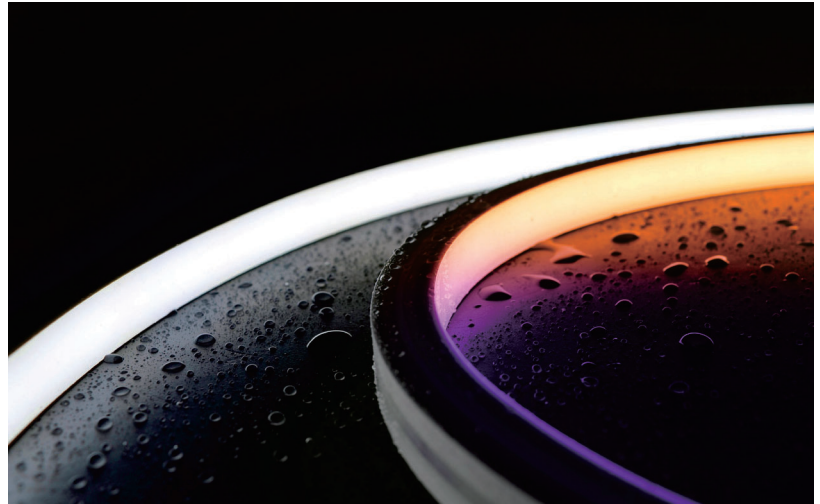

DMX512

Compatible with international standard protocol DMX512 (1990).
Adopting signal differential transmission mode, to ensure stronger anti-interference ability and longer transmission distance.

Product List

Model	Voltage (V)	Power (W/M)	Lumen (LM/M)	Efficiency (LM/W)	Pixel (PCS)	Unit length (mm)	IC Model	Page
ES-NS-T1615-RGB-WS2818	DC24V	12	262	21.8	8	125	UCS2603 WS2818	01
ES-NS-T1615-RGBW-UCS2904	DC24V	14.5	342	23.6	8	125	UCS2904	
ES-NS-T1615-RGB-DMX512	DC24V	12	266	22.2	8	125	UCS512C2L	
ES-NS-T1615-RGBW-DMX512	DC24V	15	329	21.9	8	125	UCS512C2L	
ES-NS-S1220-RGB-WS2818	DC24V	12	159	13.3	8	125	UCS2603 WS2818	03
ES-NS-S1220-RGBW-UCS2904	DC24V	14.5	218	15.0	8	125	UCS2904	
ES-NS-S1220-RGB-DMX512	DC24V	12	161	13.4	8	125	UCS512C2L	
ES-NS-S1220-RGBW-DMX512	DC24V	15	211	14.1	8	125	UCS512C2L	
ES-NS-S1225-RGB-WS2818	DC24V	12	145	12.1	8	125	UCS2603 WS2818	05
ES-NS-S1225-RGBW-UCS2904	DC24V	14.5	200	13.8	8	125	UCS2904	
ES-NS-S1225-RGB-DMX512	DC24V	12	148	12.3	8	125	UCS512C2L	
ES-NS-S1225-RGBW-DMX512	DC24V	15	208	13.9	8	125	UCS512C2L	
ES-NS-T1212-RGB-WS2811	DC24V	12.5	266	21.3	10	100	WS2811	07
ES-NS-S0612-RGB-WS2811	DC24V	12.5	162	13.0	10	100	WS2811	08
ES-NS-S0817-RGB-WS2811	DC24V	12.5	152	12.2	10	100	WS2811	09
ES-NS-T1010-RGB-WS2811	DC24V	12.5	304	24.3	10	100	WS2811	10
ES-NS-D16-RGB-WS2811	DC24V	12.5	294	23.5	10	100	WS2811	11
ES-NS-S0612D-RGB-WS2811	DC24V	12.5	266	21.3	10	100	WS2811	12
ES-NS-R25-RGB-WS2811	DC24V	25	474	19	10	100	WS2811	13

Note: If there are multiple IC model options for a product in the selection table, it only means that the PCB can be compatible with the listed IC models, but it does not mean that the control protocols of the listed IC are the same. When the customer chooses the controller by himself, please check whether the controller supports the IC of the specified light strip.

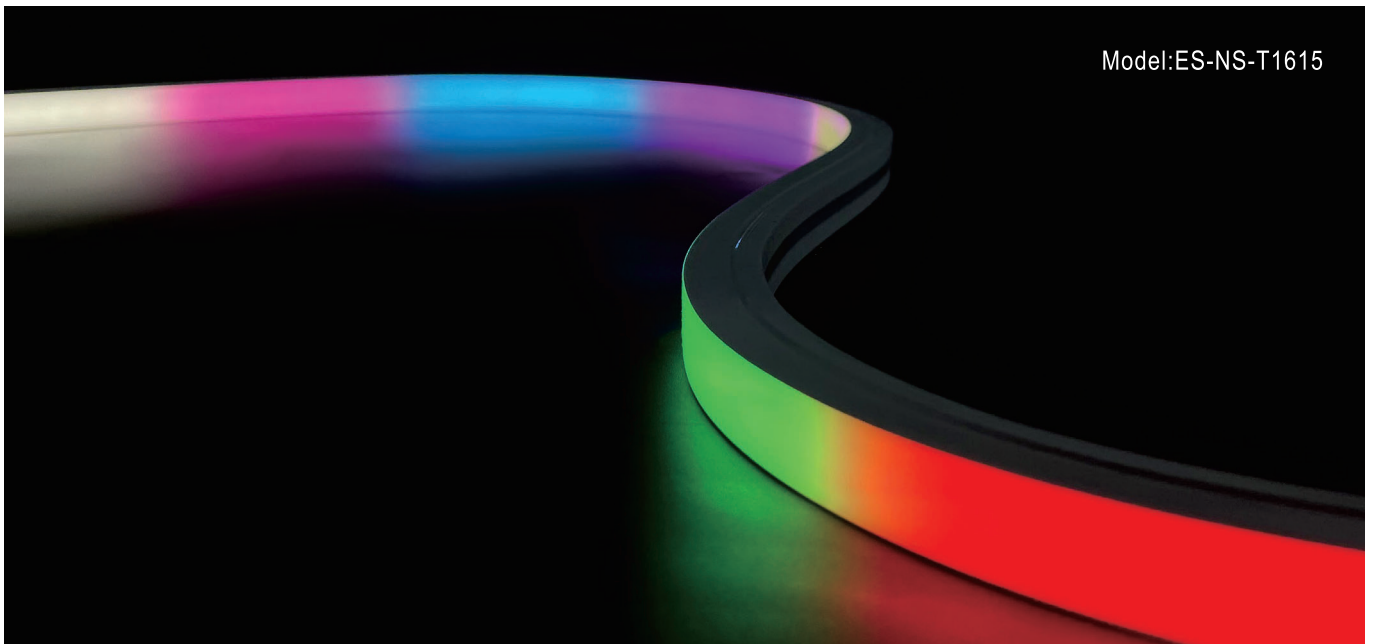

Product Features

- It is made of Dow Chemical SILASTIC™ ET-7021 silicone rubber, which provides high transparency and high strength.
- Environmental protection grade silicone material, integrated extrusion molding process.
- Unique optical light distribution structure design, uniform lighting surface and no shadow.
- IP67 protection level, salt solution resistance, weak acid and alkali corrosion and UV.
- Excellent toughness, simple and stylish appearance, delicate and unique.
- 3 years warranty, working life ≥ 30000 hours;

Dimension structure

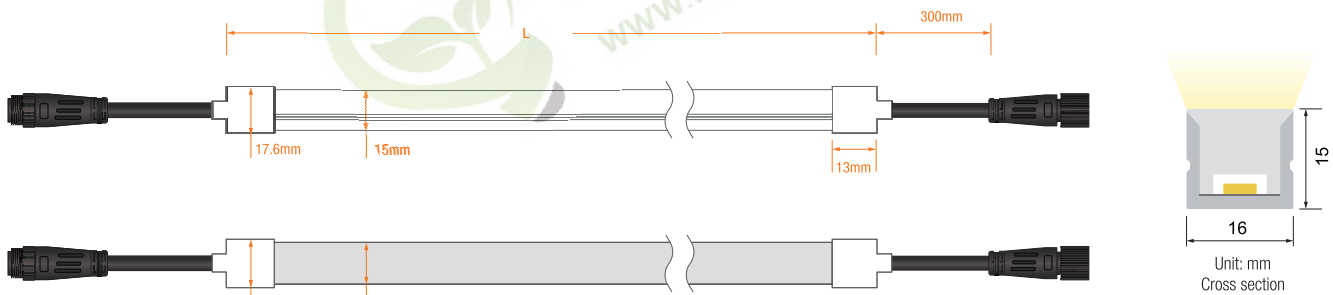

Cable

Cable Type	Schematic Diagram	Specification	Core	Electrical Properties
PVC Cable		OD: 5.0mm	● ● ●	SPI: Red V+, Green DI/DO, Black V-
		OD: 5.5mm	● ● ● ●	Breakpoint Transmission: RedV+, GreenBI/BO, BlueDI/DO, BlackV-
		OD: 5.5mm	● ● ● ○ ●	DMX512: RedV+, GreenPI/PO, BlueAI/AO, WhiteBI/BO, BlackV-
Silicone Cable		OD: 5.0mm	● ● ●	SPI: RedV+, GreenDI/DO, BlackV-
		OD: 6.0mm	● ● ● ●	Breakpoint Transmission: RedV+, GreenBI/BO, BlueDI/DO, BlackV-
		OD: 6.0mm	● ● ● ○ ●	DMX512: RedV+, GreenPI/PO, BlueAI/AO, WhiteBI/BO, BlackV-

RGB (ES-NS-T1615-RGB-WS2818)

Voltage (V)	Power (W/M)	CCT/Color	Lumen (LM/M)	Efficiency (LM/W)	Pixel (PCS)	Unit length (mm)	Signal Type	IC Model
DC24V	5	R	48	9.6	8	125	Breakpoint Transmission	UCS2603/WS2818
	5	G	184	36.8				
	5	B	32	6.4				
	12	RGB	262	21.8				

RGBW (ES-NS-T1615-RGBW-UCS2904)

Voltage (V)	Power (W/M)	CCT/Color	Lumen (LM/M)	Efficiency (LM/W)	Pixel (PCS)	Unit length (mm)	Signal Type	IC Model
DC24V	4.8	R	42	8.8	8	125	SPI	UCS2904
	4.8	G	117	24.4				
	4.8	B	36	7.5				
	4.8	W(4000K)	162	33.8				
	14.5	RGBW	342	23.6				

RGB (ES-NS-T1615-RGB-DMX512)

Voltage (V)	Power (W/M)	CCT/Color	Lumen (LM/M)	Efficiency (LM/W)	Pixel (PCS)	Unit length (mm)	Signal Type	IC Model
DC24V	4.8	R	51	10.6	8	125	DMX512	UCS512C2L
	4.8	G	191	39.8				
	4.8	B	32	6.7				
	12	RGB	266	22.2				

RGBW (ES-NS-T1615-RGBW-DMX512)

Voltage (V)	Power (W/M)	CCT/Color	Lumen (LM/M)	Efficiency (LM/W)	Pixel (PCS)	Unit length (mm)	Signal Type	IC Model
DC24V	4.8	R	44	9.2	8	125	DMX512	UCS512C2L
	4.8	G	119	24.8				
	4.8	B	34	7.1				
	4.8	W(4000K)	153	31.9				
	15	RGBW	329	21.9				

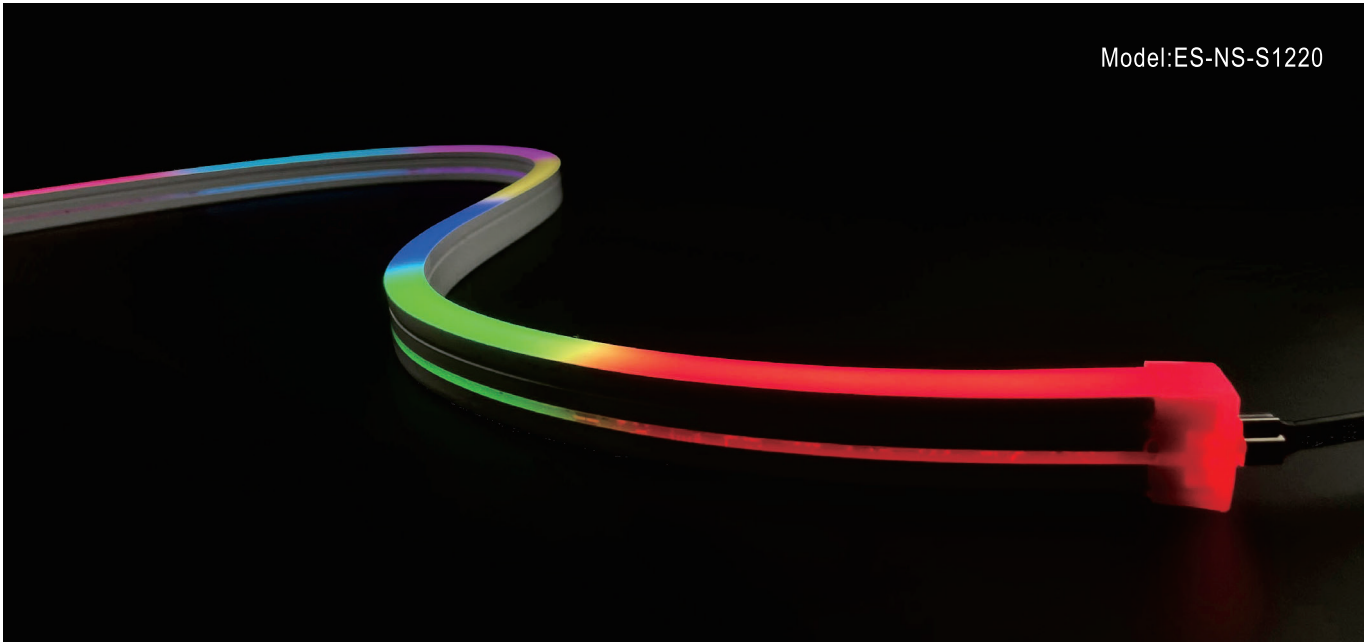

Product Features

- It is made of Dow Chemical SILASTIC™ ET-7021 silicone rubber, which provides high transparency and high strength.
- Environmental protection grade silicone material, integrated extrusion molding process.
- Unique optical light distribution structure design, uniform lighting surface and no shadow.
- IP67 protection level, salt solution resistance, weak acid and alkali corrosion and UV.
- Excellent toughness, simple and stylish appearance, delicate and unique.
- 3 years warranty, working life \geq 30000 hours;

Dimension structure

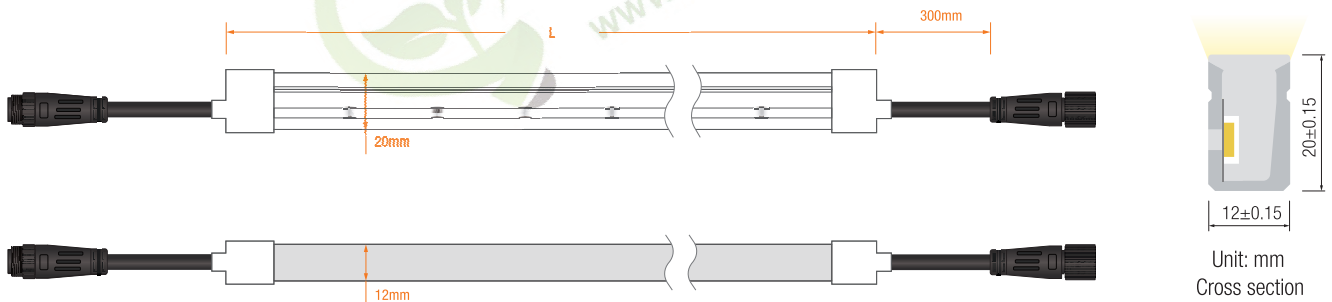

Cable

Cable Type	Schematic Diagram	Specification	Core	Electrical Properties
PVC Cable		OD: 5.0mm	● ● ●	SPI: Red V+, Green DI/DO, Black V-
		OD: 5.5mm	● ● ● ●	Breakpoint Transmission: RedV+, GreenBI/BO, BlueDI/DO, BlackV-
		OD: 5.5mm	● ● ● ● ●	DMX512: RedV+, GreenPI/PO, BlueAI/AO, WhiteBI/BO, BlackV-
Silicone Cable		OD: 5.0mm	● ● ●	SPI: RedV+, GreenDI/DO, BlackV-
		OD: 6.0mm	● ● ● ●	Breakpoint Transmission: RedV+, GreenBI/BO, BlueDI/DO, BlackV-
		OD: 6.0mm	● ● ● ● ●	DMX512: RedV+, GreenPI/PO, BlueAI/AO, WhiteBI/BO, BlackV-

RGB (ES-NS-T1220-RGB-WS2818)

Voltage (V)	Power (W/M)	CCT/Color	Lumen (LM/M)	Efficiency (LM/W)	Pixel (PCS)	Unit length (mm)	Signal Type	IC Model
DC24V	5	R	28	5.6	8	125	Breakpoint Transmission	UCS2603/WS2818
	5	G	110	22.1				
	5	B	20	4.0				
	12	RGB	159	13.2				

RGBW (ES-NS-T1220-RGBW-UCS2904)

Voltage (V)	Power (W/M)	CCT/Color	Lumen (LM/M)	Efficiency (LM/W)	Pixel (PCS)	Unit length (mm)	Signal Type	IC Model
DC24V	4.8	R	29	6.0	8	125	SPI	UCS2904
	4.8	G	78	16.3				
	4.8	B	23	4.8				
	4.8	W(4000K)	96	20.0				
	14.5	RGBW	218	15.0				

RGB (ES-NS-T1220-RGB-DMX512)

Voltage (V)	Power (W/M)	CCT/Color	Lumen (LM/M)	Efficiency (LM/W)	Pixel (PCS)	Unit length (mm)	Signal Type	IC Model
DC24V	4.8	R	30	6.3	8	125	DMX512	UCS512C2L
	4.8	G	115	24.0				
	4.8	B	20	4.2				
	12	RGB	161	13.4				

RGBW (ES-NS-T1220-RGBW-DMX512)

Voltage (V)	Power (W/M)	CCT/Color	Lumen (LM/M)	Efficiency (LM/W)	Pixel (PCS)	Unit length (mm)	Signal Type	IC Model
DC24V	4.8	R	28	5.8	8	125	DMX512	UCS512C2L
	4.8	G	80	16.7				
	4.8	B	16	3.3				
	4.8	W(4000K)	96	20.0				
	15	RGBW	211	14.1				

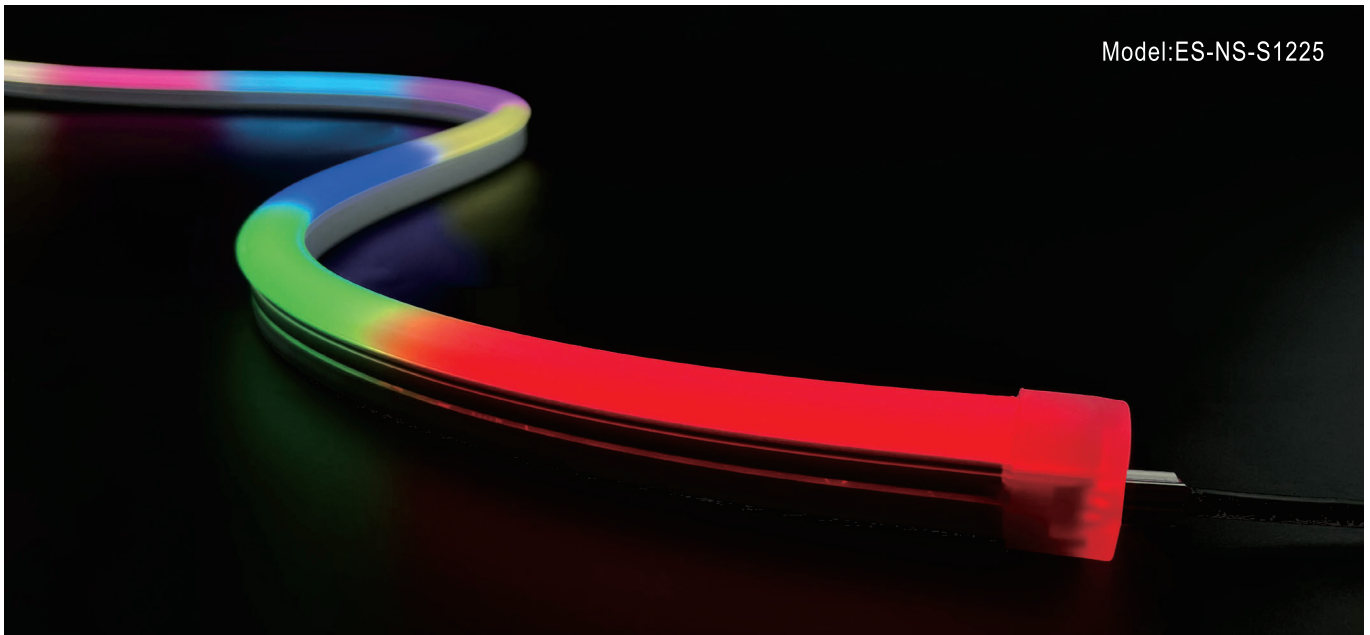

Product Features

- It is made of Dow Chemical SILASTIC™ ET-7021 silicone rubber, which provides high transparency and high strength.
- Environmental protection grade silicone material, integrated extrusion molding process.
- Unique optical light distribution structure design, uniform lighting surface and no shadow.
- IP67 protection level, salt solution resistance, weak acid and alkali corrosion and UV.
- Excellent toughness, simple and stylish appearance, delicate and unique.
- 3 years warranty, working life \geq 30000 hours;

Dimension structure

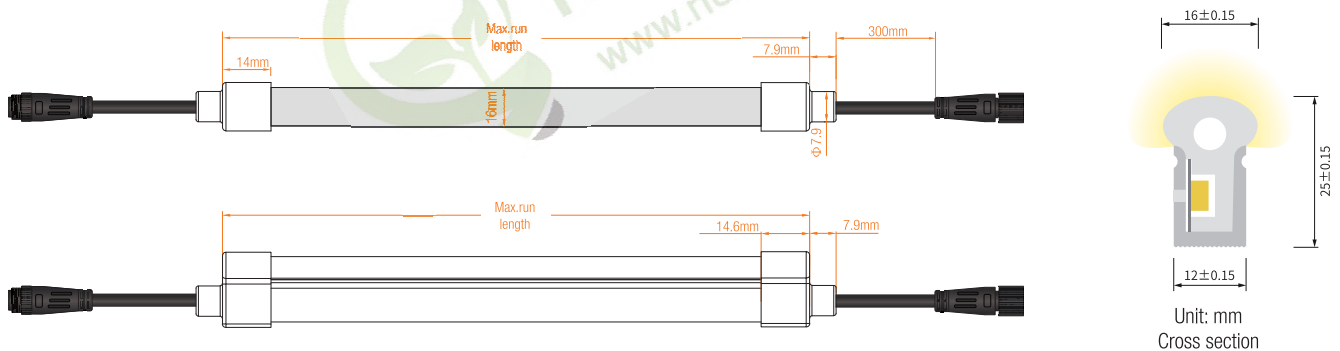

Cable

Cable Type	Schematic Diagram	Specification	Core	Electrical Properties
PVC Cable		OD: 5.0mm	● ● ●	SPI: Red V+, Green DI/DO, BlackV-
		OD: 5.5mm	● ● ● ●	Breakpoint Transmission: RedV+, GreenBI/BO, BlueDI/DO, BlackV-
		OD: 5.5mm	● ● ● ○ ●	DMX512: RedV+, GreenPI/PO, BlueAI/AO, WhiteBI/BO, BlackV-
Silicone Cable		OD: 5.0mm	● ● ●	SPI: RedV+, GreenDI/DO, BlackV-
		OD: 6.0mm	● ● ● ●	Breakpoint Transmission: RedV+, GreenBI/BO, BlueDI/DO, BlackV-
		OD: 6.0mm	● ● ● ○ ●	DMX512: RedV+, GreenPI/PO, BlueAI/AO, WhiteBI/BO, BlackV-

RGB (ES-NS-S1225-RGB-WS2818)

Voltage (V)	Power (W/M)	CCT/Color	Lumen (LM/M)	Efficiency (LM/W)	Pixel (PCS)	Unit length (mm)	Signal Type	IC Model
DC24V	5	R	25	5.0	8	125	Breakpoint Transmission	UCS2603/WS2818
	5	G	102	20.4				
	5	B	19	3.8				
	12	RGB	145	12.1				

RGBW (ES-NS-S1225-RGBW-UCS2904)

Voltage (V)	Power (W/M)	CCT/Color	Lumen (LM/M)	Efficiency (LM/W)	Pixel (PCS)	Unit length (mm)	Signal Type	IC Model
DC24V	4.8	R	24	5.0	8	125	SPI	UCS2904
	4.8	G	72	15.0				
	4.8	B	22	4.6				
	4.8	W(4000K)	87	18.1				
	14.5	RGBW	200	13.8				

RGB (ES-NS-S1225-RGB-DMX512)

Voltage (V)	Power (W/M)	CCT/Color	Lumen (LM/M)	Efficiency (LM/W)	Pixel (PCS)	Unit length (mm)	Signal Type	IC Model
DC24V	4.8	R	27	5.6	8	125	DMX512	UCS512C2L
	4.8	G	107	22.3				
	4.8	B	19	4.0				
	12	RGB	148	12.3				

RGBW (ES-NS-S1225-RGBW-DMX512)

Voltage (V)	Power (W/M)	CCT/Color	Lumen (LM/M)	Efficiency (LM/W)	Pixel (PCS)	Unit length (mm)	Signal Type	IC Model
DC24V	4.8	R	26	5.4	8	125	DMX512	UCS512C2L
	4.8	G	74	15.4				
	4.8	B	23	4.8				
	4.8	W(4000K)	90	18.8				
	15	RGBW	208	13.9				

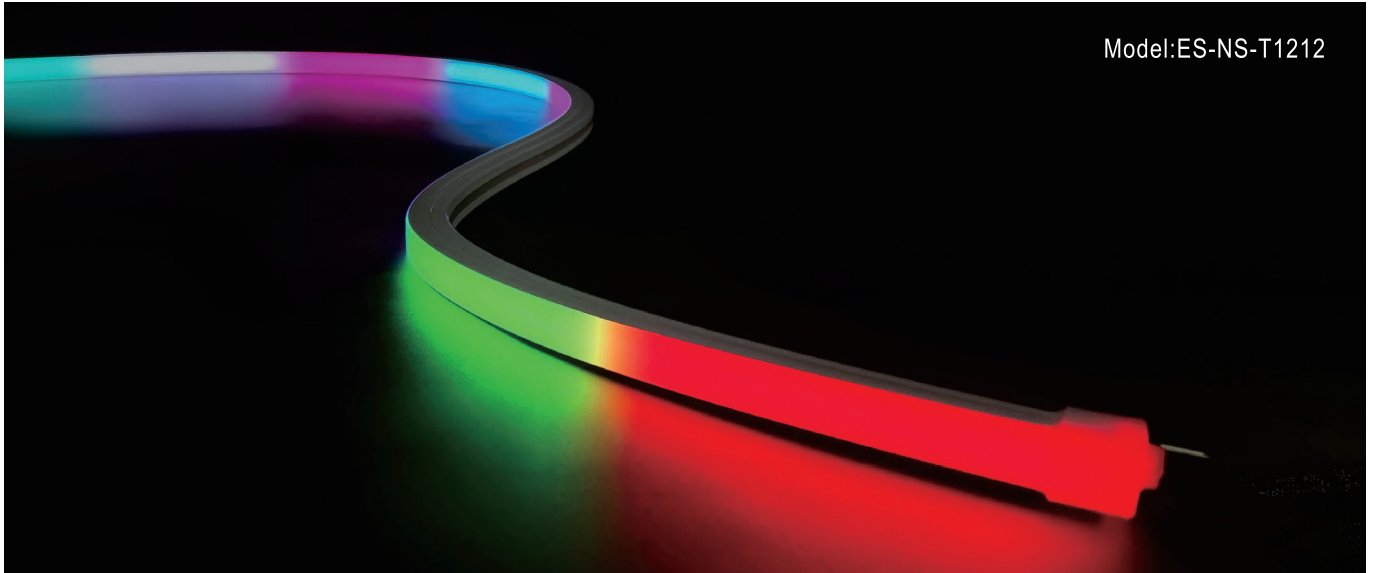

Product Features

- It is made of Dow Chemical SILASTIC™ ET-7021 silicone rubber, which provides high transparency and high strength.
- Environmental protection grade silicone material, integrated extrusion molding process.
- Unique optical light distribution structure design, uniform lighting surface and no shadow.
- IP67 protection level, salt solution resistance, weak acid and alkali corrosion and UV.
- Excellent toughness, simple and stylish appearance, delicate and unique.
- 3 years warranty, working life > 30000 hours;

Dimension structure

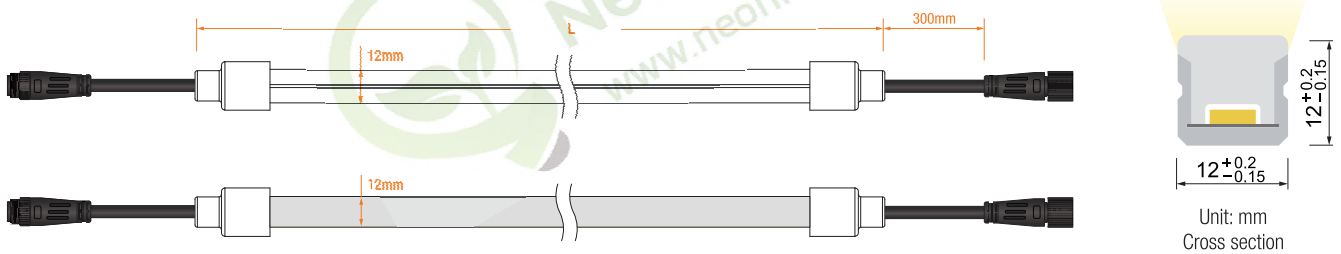

Cable

Cable Type	Schematic Diagram	Specification	Core	Electrical Properties
PVC Cable		OD: 5.0mm	● ● ●	SPI: Red V+, Green DI/DO, Black V-

RGB

Voltage (V)	Power (W/M)	CCT/Color	Lumen (LM/M)	Efficiency (LM/W)	Pixel (PCS)	Unit length (mm)	Signal Type	IC Model
DC24V	4.8	R	60	12.5	10	100	SPI	WS2811
	4.8	G	194	40.4				
	4.8	B	33	6.9				
	12.5	RGB	266	21.3				



Product Features

- It is made of Dow Chemical SILASTIC™ ET-7021 silicone rubber, which provides high transparency and high strength.
- Environmental protection grade silicone material, integrated extrusion molding process.
- Unique optical light distribution structure design, uniform lighting surface and no shadow.
- IP67 protection level, salt solution resistance, weak acid and alkali corrosion and UV.
- Excellent toughness, simple and stylish appearance, delicate and unique.
- 3 years warranty, working life \geq 30000 hours;

Dimension structure

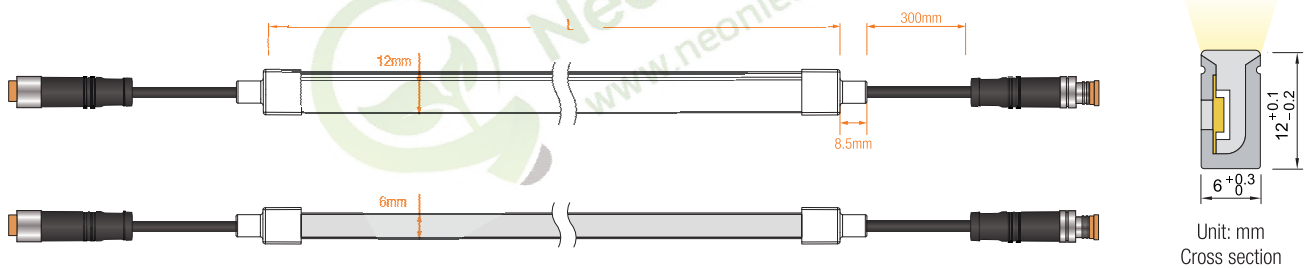

Cable

Cable Type	Schematic Diagram	Specification	Core	Electrical Properties
PVC Cable		OD: 4.0mm	● ● ●	SPI: Red V+, Green DI/DO, Black V-

RGB

Voltage (V)	Power (W/M)	CCT/Color	Lumen (LM/M)	Efficiency (LM/W)	Pixel (PCS)	Unit length (mm)	Signal Type	IC Model
DC24V	4.8	R	42	8.8	10	100	SPI	WS2811
	4.8	G	122	25.4				
	4.8	B	22	4.6				
	12.5	RGB	162	13.0				

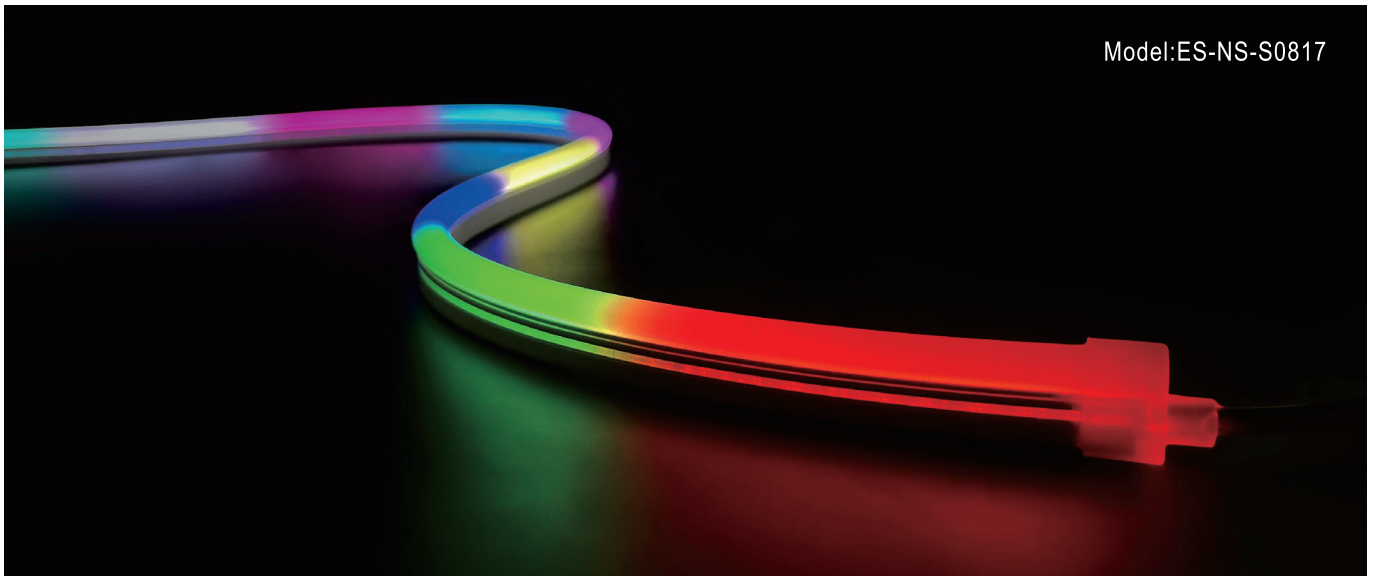

Product Features

- It is made of Dow Chemical SILASTIC™ ET-7021 silicone rubber, which provides high transparency and high strength.
- Environmental protection grade silicone material, integrated extrusion molding process.
- Unique optical light distribution structure design, uniform lighting surface and no shadow.
- IP67 protection level, salt solution resistance, weak acid and alkali corrosion and UV.
- Excellent toughness, simple and stylish appearance, delicate and unique.
- 3 years warranty, working life > 30000 hours;

Dimension structure

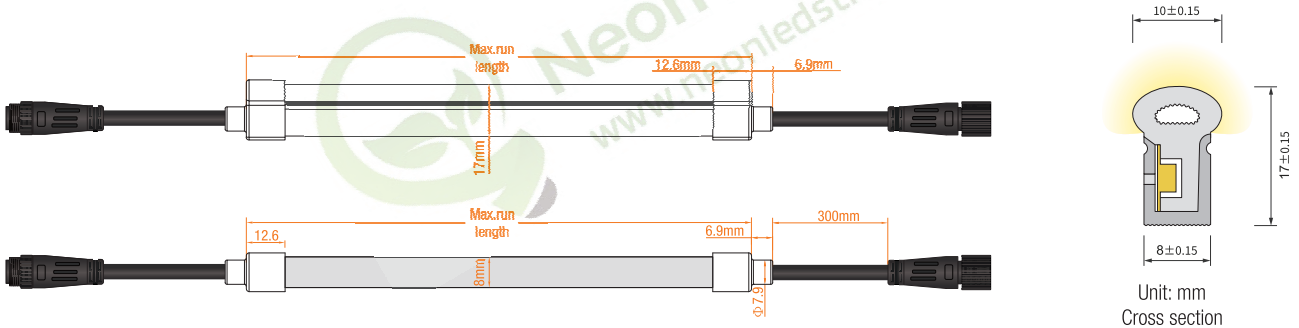

Cable

Cable Type	Schematic Diagram	Specification	Core	Electrical Properties
PVC Cable		OD: 5.0mm	● ● ●	SPI: Red V+, Green DI/DO, Black V-

RGB

Voltage (V)	Power (W/M)	CCT/Color	Lumen (LM/M)	Efficiency (LM/W)	Pixel (PCS)	Unit length (mm)	Signal Type	IC Model
DC24V	4.8	R	36	7.5	10	100	SPI	WS2811
	4.8	G	114	23.8				
	4.8	B	19	4.0				
	12.5	RGB	152	12.2				

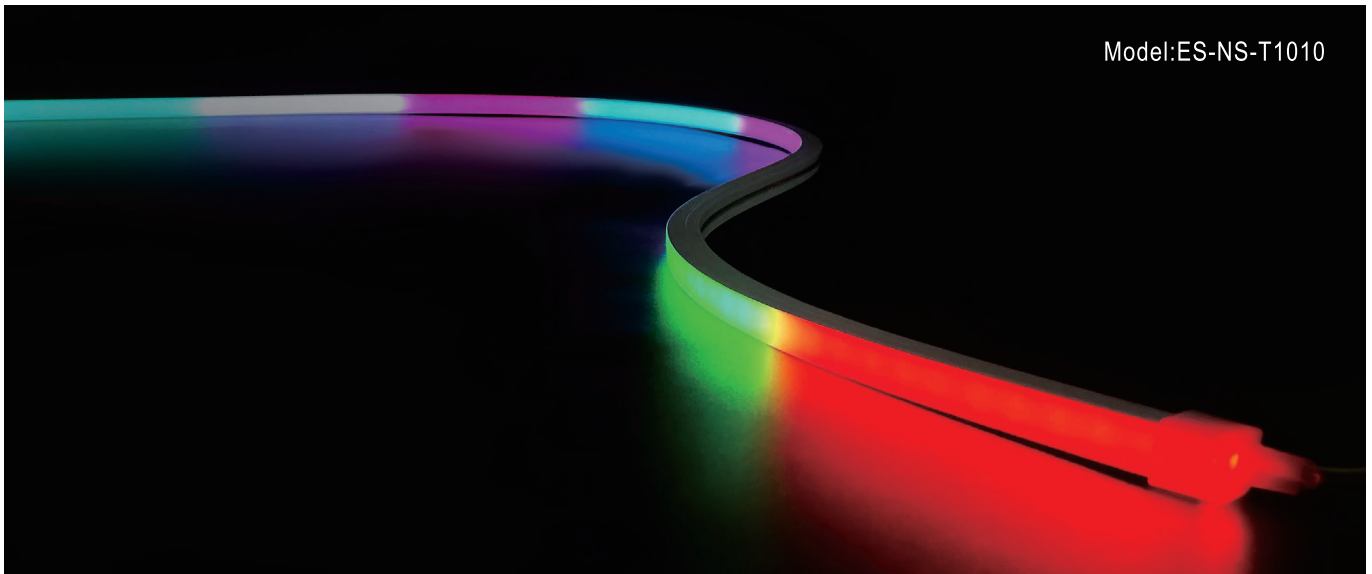

Product Features

- It is made of Dow Chemical SILASTIC™ ET-7021 silicone rubber, which provides high transparency and high strength.
- Environmental protection grade silicone material, integrated extrusion molding process.
- Unique optical light distribution structure design, uniform lighting surface and no shadow.
- IP67 protection level, salt solution resistance, weak acid and alkali corrosion and UV.
- Excellent toughness, simple and stylish appearance, delicate and unique.
- 3 years warranty, working life > 30000 hours;

Dimension structure

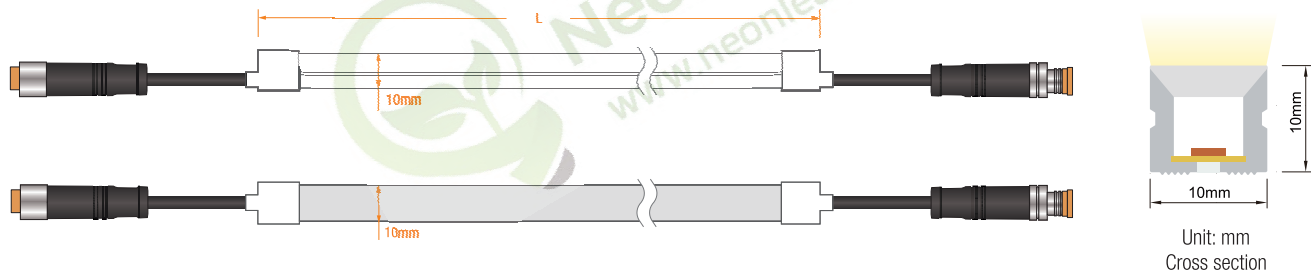

Cable

Cable Type	Schematic Diagram	Specification	Core	Electrical Properties
PVC Cable		OD: 4.0mm	● ● ●	SPI: Red V+, Green DI/DO, Black V-

RGB

Voltage (V)	Power (W/M)	CCT/Color	Lumen (LM/M)	Efficiency (LM/W)	Pixel (PCS)	Unit length (mm)	Signal Type	IC Model
DC24V	4.8	R	69	14.4	10	100	SPI	WS2811
	4.8	G	216	45.0				
	4.8	B	35	7.3				
	12.5	RGB	304	24.3				

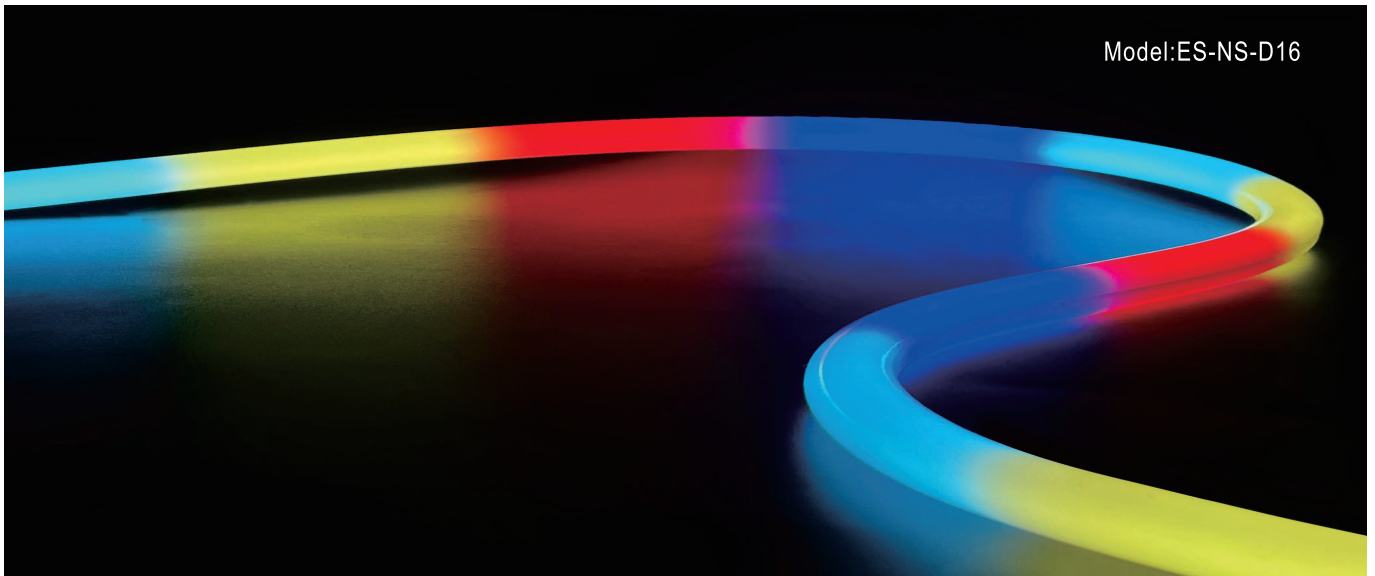

Product Features

- It is made of Dow Chemical SILASTIC™ ET-7021 silicone rubber, which provides high transparency and high strength.
- Environmental protection grade silicone material, integrated extrusion molding process.
- Unique optical light distribution structure design, uniform lighting surface and no shadow.
- IP67 protection level, salt solution resistance, weak acid and alkali corrosion and UV.
- Excellent toughness, simple and stylish appearance, delicate and unique.
- 3 years warranty, working life > 30000 hours;

Dimension structure

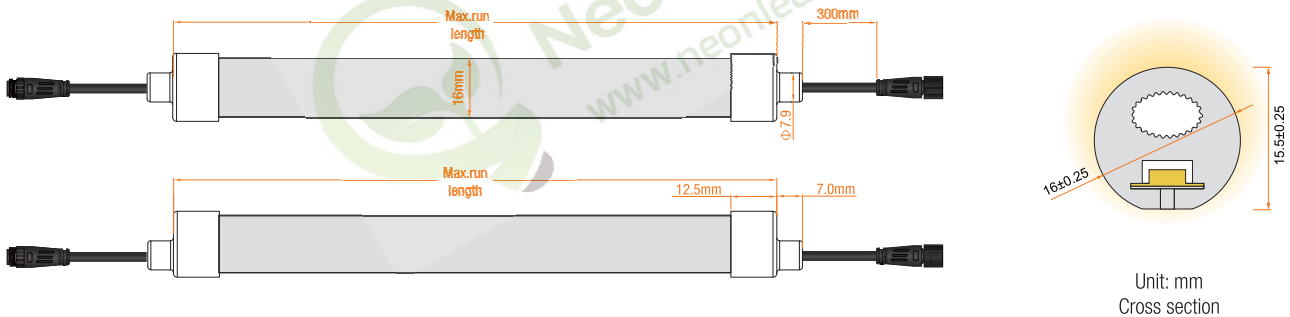

Cable

Cable Type	Schematic Diagram	Specification	Core	Electrical Properties
PVC Cable		OD: 5.0mm	● ● ●	SPI: Red V+, Green DI/DO, Black V-

RGB

Voltage (V)	Power (W/M)	CCT/Color	Lumen (LM/M)	Efficiency (LM/W)	Pixel (PCS)	Unit length (mm)	Signal Type	IC Model
DC24V	4.8	R	69	14.4	10	100	SPI	WS2811
	4.8	G	219	45.6				
	4.8	B	41	8.5				
	12.5	RGB	294	23.5				

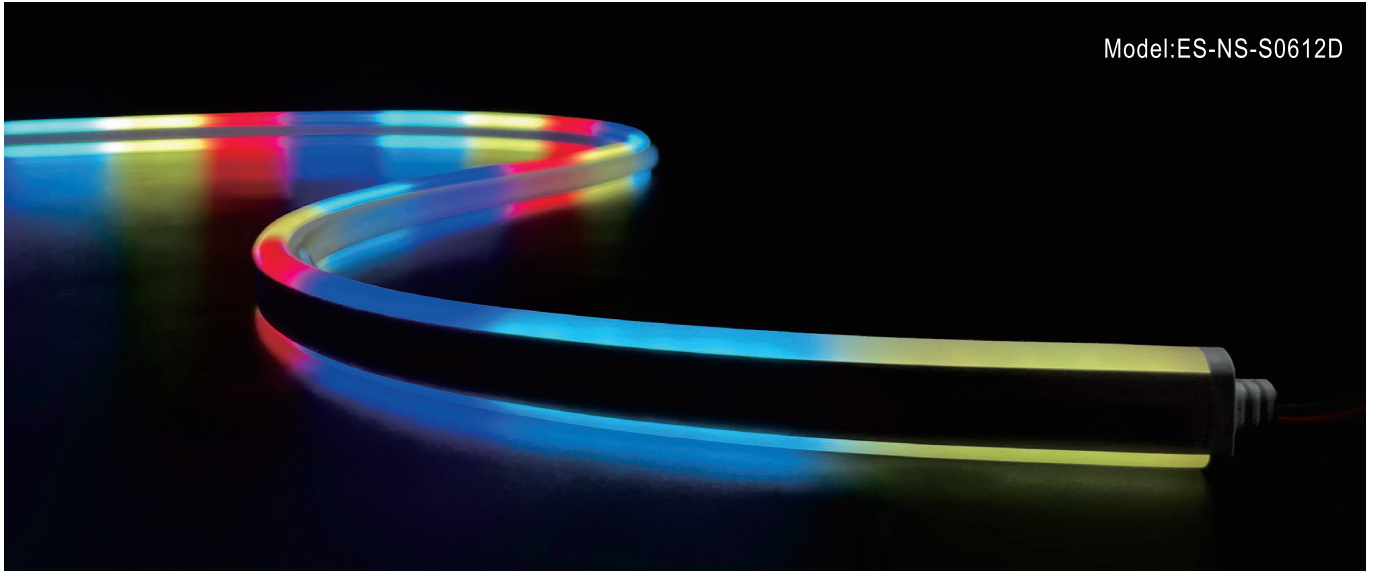

Product Features

- It is made of Dow Chemical SILASTIC™ ET-7021 silicone rubber, which provides high transparency and high strength.
- Environmental protection grade silicone material, integrated extrusion molding process.
- Unique optical light distribution structure design, uniform lighting surface and no shadow.
- IP65 protection level, salt solution resistance, weak acid and alkali corrosion and UV.
- Excellent toughness, simple and stylish appearance, delicate and unique.
- 3 years warranty, working life > 30000 hours;

Dimension structure

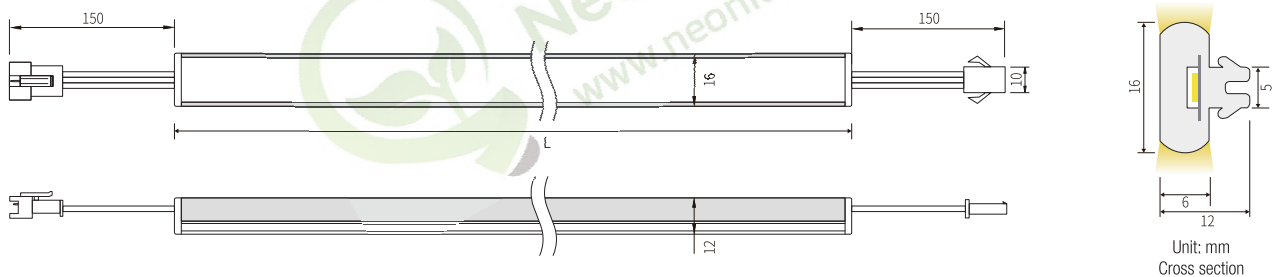

Cable

Cable Type	Schematic Diagram	Specification	Core	Electrical Properties
PVC Cable		OD: 5.0mm	● ● ●	SPI: Red V+, Green DI/DO, Black V-

RGB

Voltage (V)	Power (W/M)	CCT/Color	Lumen (LM/M)	Efficiency (LM/W)	Pixel (PCS)	Unit length (mm)	Signal Type	IC Model
DC24V	4.8	R	64	13.3	10	100	SPI	WS2811
	4.8	G	199	41.5				
	4.8	B	34	7.1				
	12.5	RGB	273	21.8				

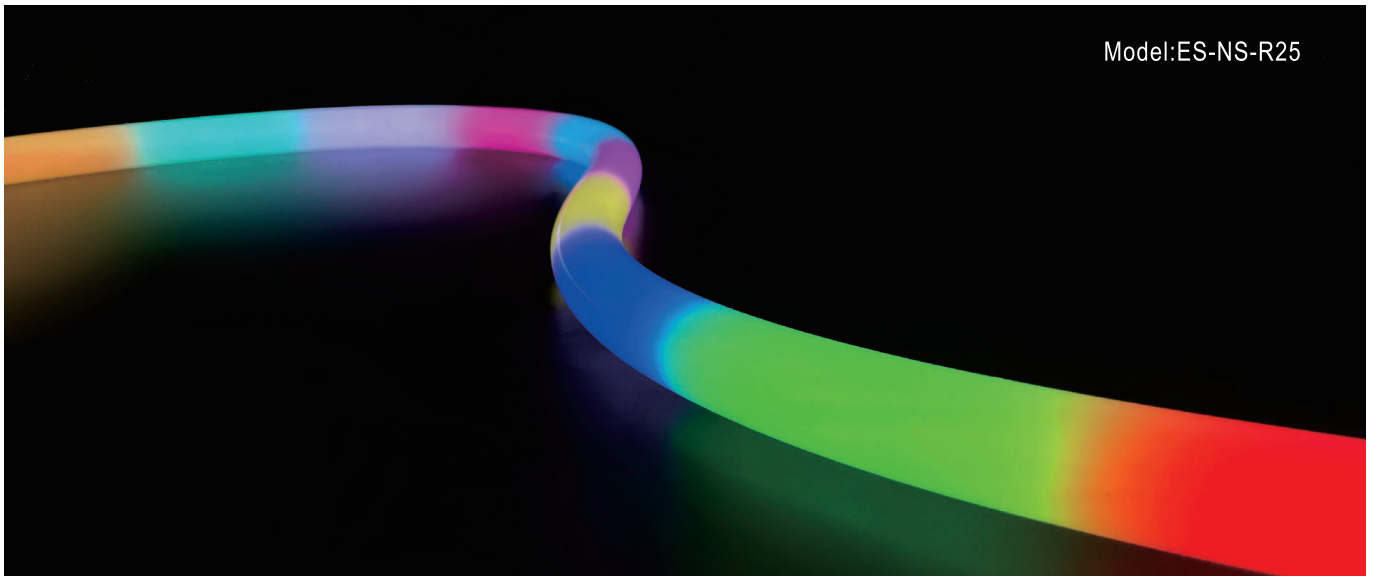

Product Features

- It is made of Dow Chemical SILASTIC™ ET-7021 silicone rubber, which provides high transparency and high strength.
- Environmental protection grade silicone material, integrated extrusion molding process.
- Unique optical light distribution structure design, uniform lighting surface and no shadow.
- IP65 protection level, salt solution resistance, weak acid and alkali corrosion and UV.
- Excellent toughness, simple and stylish appearance, delicate and unique.
- 3 years warranty, working life > 30000 hours;

Dimension structure

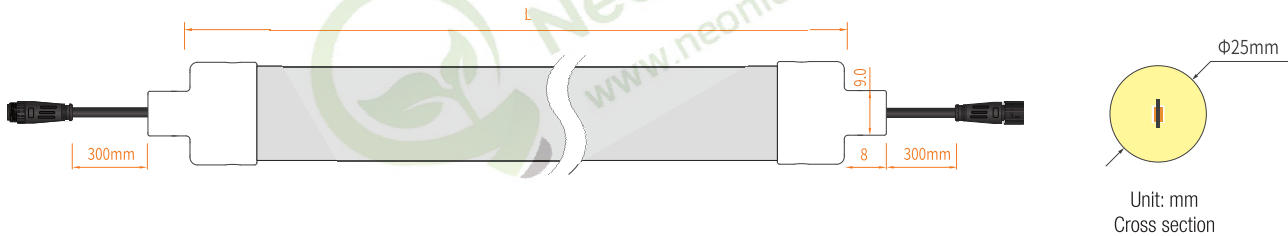

Cable

Cable Type	Schematic Diagram	Specification	Core	Electrical Properties
PVC Cable		OD: 5.0mm	● ● ●	SPI: Red V+, Green DI/DO, Black V-
Silicone Cable		OD: 5.0mm	● ● ●	SPI: Red V+, Green DI/DO, Black V-

RGB

Voltage (V)	Power (W/M)	CCT/Color	Lumen (LM/M)	Efficiency (LM/W)	Pixel (PCS)	Unit length (mm)	Signal Type	IC Model
DC24V	9.6	R	112	11.7	10	100	SPI	WS2811
	9.6	G	350	36.5				
	9.6	B	54	5.6				
	25	RGB	474	19.0				