

## Application

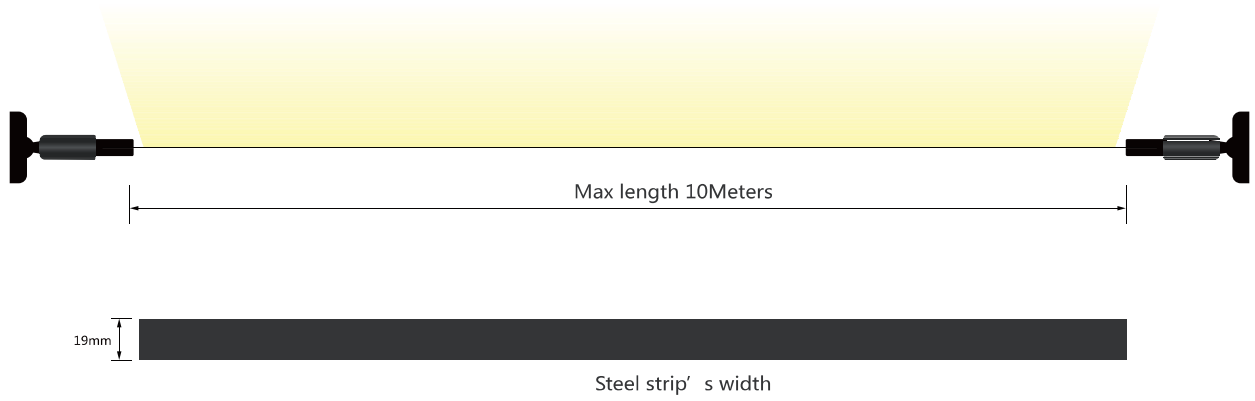

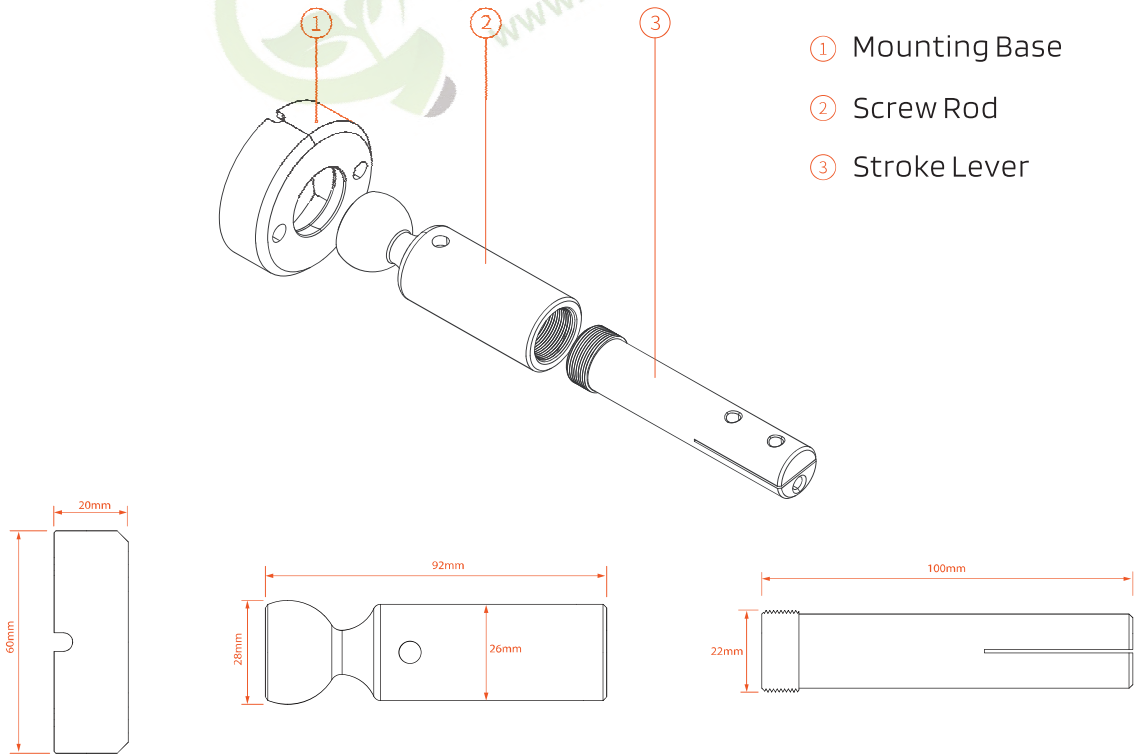

### Dimension Drawing



## Bill of material

### optional accessories



① Plastic Steel Strip



② Steel Strip

### Kit



scissors

gloves

### optional accessories

- ③ stroke lever    ④ screw rod    ⑤ Mounting base    ⑥ Connection terminal
- ⑦ Screw    ⑧ Expansion Plug    ⑨ rocket screwdrivers



## Installation Procedure

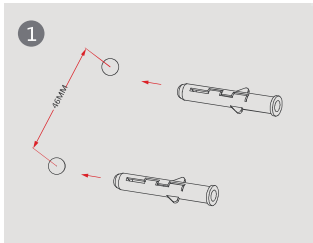

On the mounting surface drill two  $\phi 6$ mm holes with a distance of 42mm, and install a plastic expansion plug

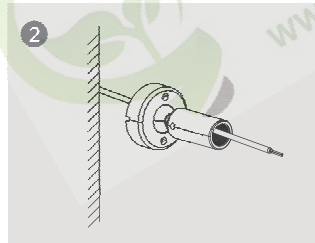

The input wire passed through the bottom box and the screw rod

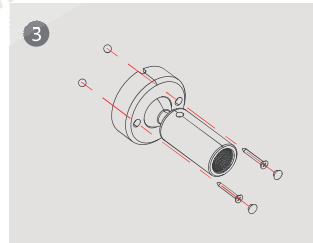

Pass the screw rod through the base and fix the base onto the mounting surface

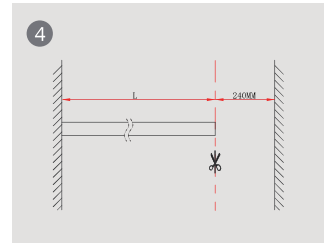

Measure the distance between two installation points, the length of the steel strip is 240mm less than the measured length.

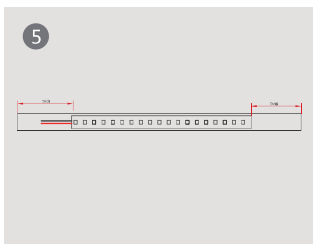

Paste the LED on the steel strip, reserve 70mm at the beginning end and 50mm at the end;

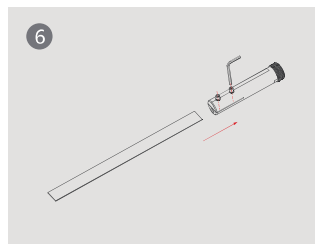

Lock the steel strip tightly with the paper travel rod

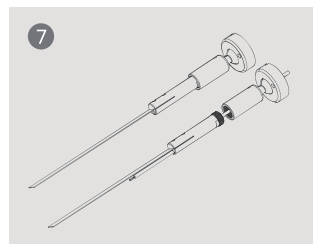

Firstly fix the stroke rod at the outlet end, then fix the stroke rod at the other end

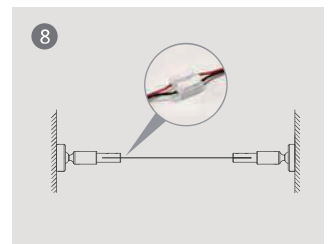

Plug the quick plug terminal on both sides and make it through by pressing tightly.

## Installation Guideline

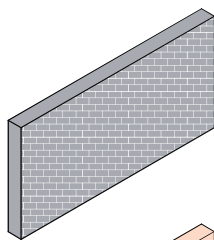
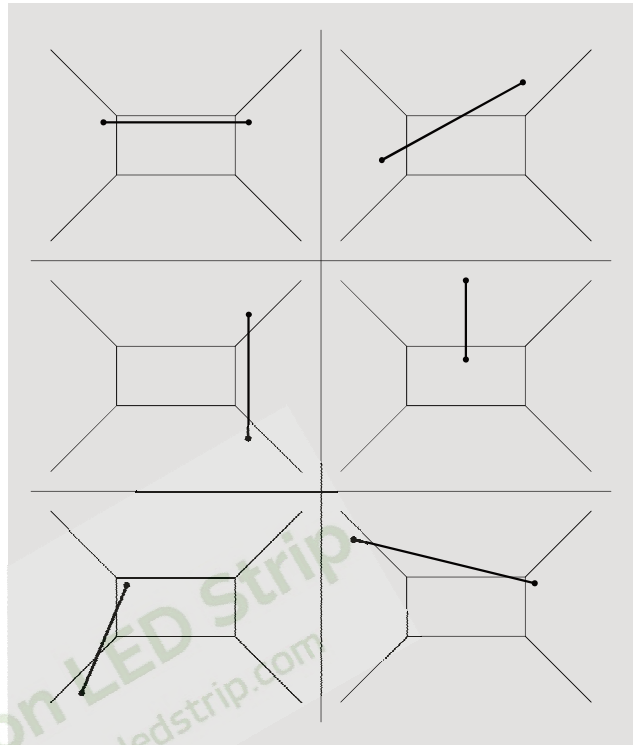
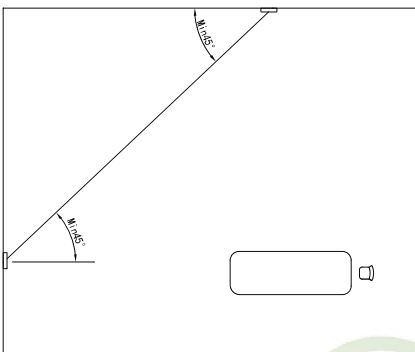
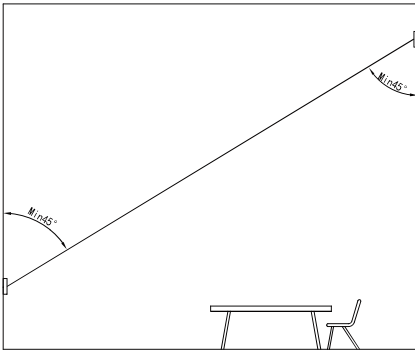

Solid brick wall

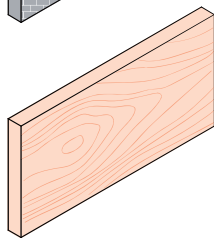

Solid wooden wall

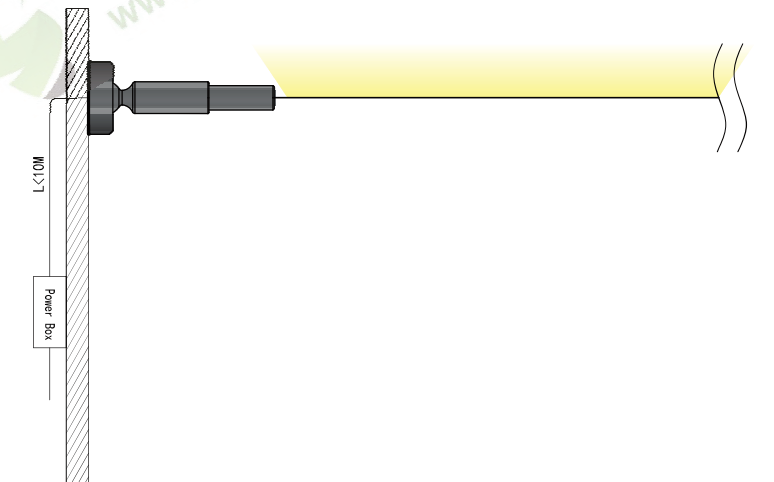

**Note:**

1. The installation surface of this product must be solid wood wall, concrete wall, brick wall, etc. Please do not install it on the surface of plaster wall or hollow wall;

2. When cutting and installing the steel strip, please wear goggles and protective gloves. The steel strip is elastic, disassemble the steel strip when it is safe.

## Packing List



parts	Specification of outer box	Packing type	Packing quantity	Gross weight of packing
Basic accessories	L65.5xW21.5xH20.5cm	Carton + CartonBOX	20pcs	9kg
Steel Strip	L37.5xW26.5xH26.5cm	Carton + CartonBOX	15pcs	5.9kg
Plastic Steel Strip	L37.5xW26.5xH26.5cm	Carton + CartonBOX	15pcs	13.7kg